



EASYSHELF





EASYSHELF



Domusomnia srl

via Don Luigi Meroni, 83
22060 Figino Serenza
Como ITALY

T +39 031 783178
info@domusomnia.com
www.domusomnia.com



EASYSHELF





EASYSHELF



Domusomnia srl

via Don Luigi Meroni, 83
22060 Figino Serenza
Como ITALY

T +39 031 783178
info@domusomnia.com
www.domusomnia.com



EASYSHELF

Anbientazione / Scene

EasyShelf è un sistema di mensole realizzato per essere applicato sui canali attrezzati EasyRack Kitchen. La componibilità modulare consente di realizzare composizioni che possono coprire tutte le misure dei canali EasyRack a partire dalla lunghezza di 750mm fino a 3000mm.

EasyShelf is a shelving system built for being affix on EasyRack Kitchen fitted frames. The modularity allows to realize compositions that can cover all the EasyRack frame's measures, from the length of 750mm to 3000mm.

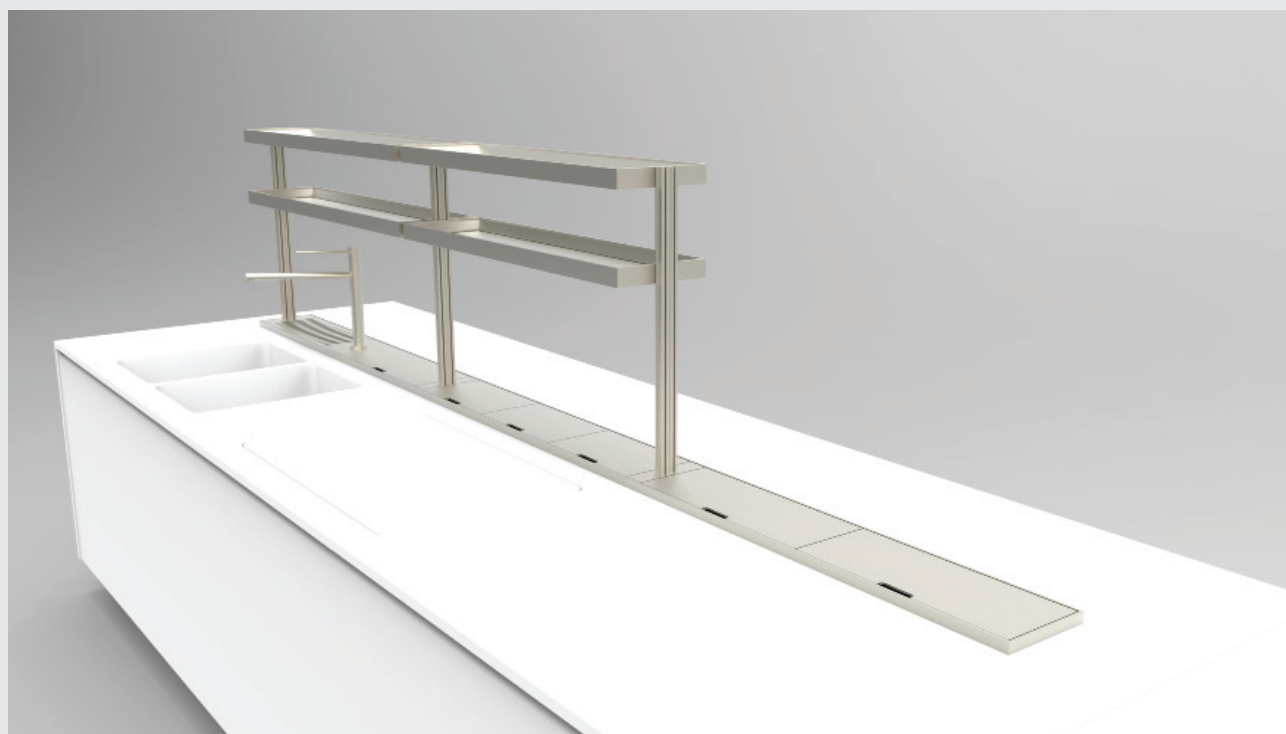
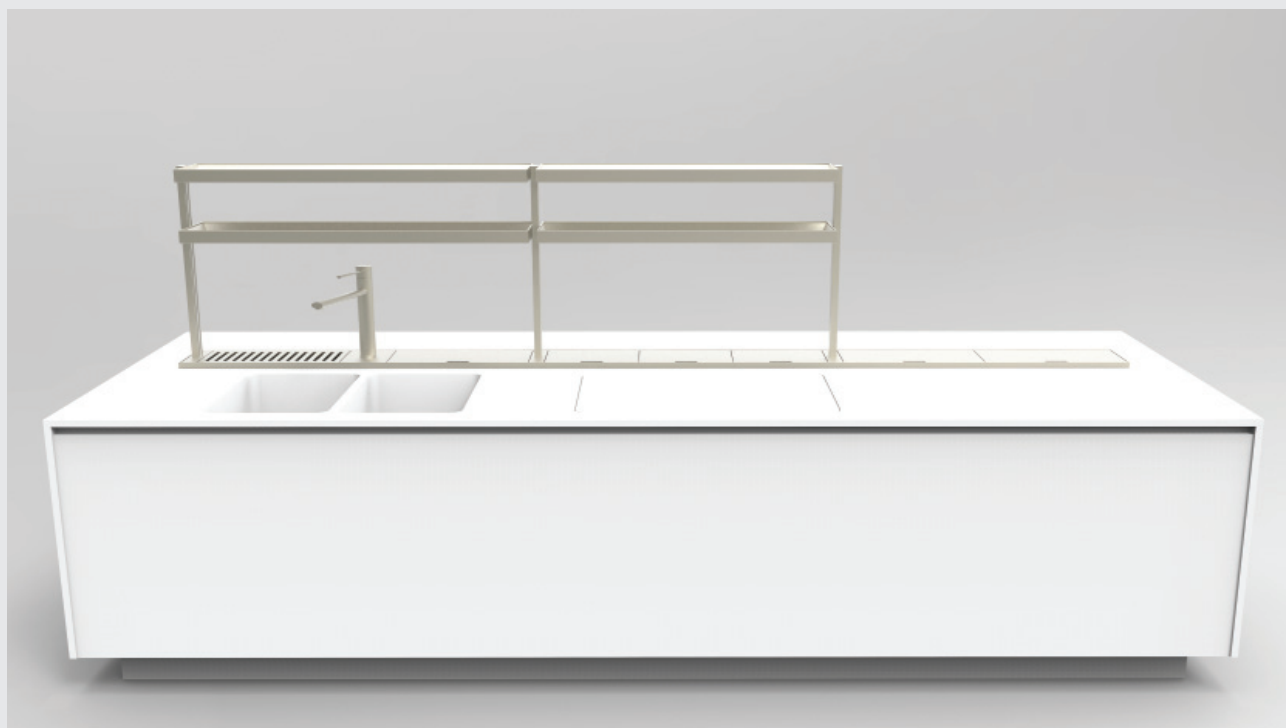



EASYSHELF

Ambientazione / Scene

EasyShelf può svilupparsi su tutta la lunghezza del canale oppure solo su una parte; a destra, a sinistra o al centro. Sono disponibili 2 altezze e 5 misure di mensole. Le mensole possono integrare un sistema di illuminazione a Led.

EasyShelf can develop over the entire length of the frame or only over one part; on the right, on the left or in the middle. There are 2 kinds of heights and 5 shelves measures. The shelves can incorporate a LED lighting system.

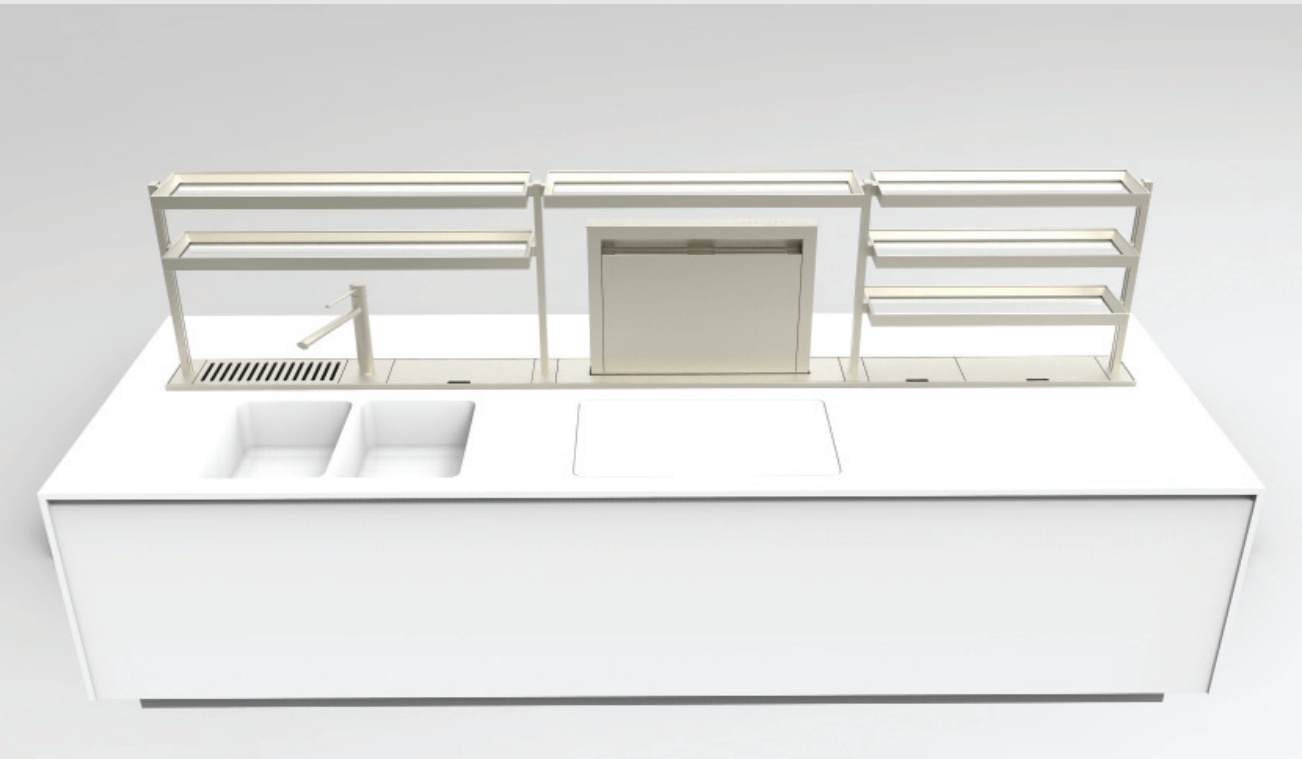
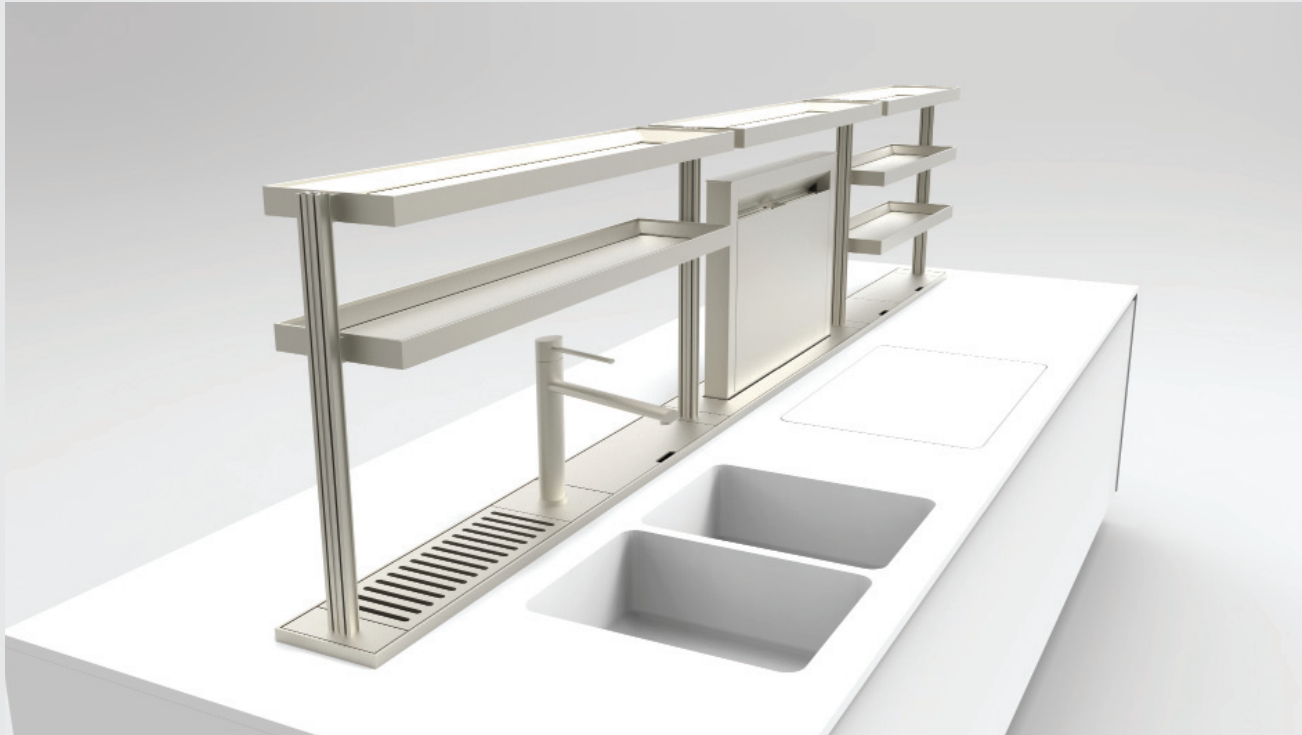



EASYSHELF

Anbientazione / Scene

EasyShelf si colloca in modo semplice sui canali EasyRack Kitchen grazie a delle basette di fissaggio già predisposte sul canale.

EasyShelf fits easily on EasyRack Kitchen frames thanks to fastening plates already prepared on the frame

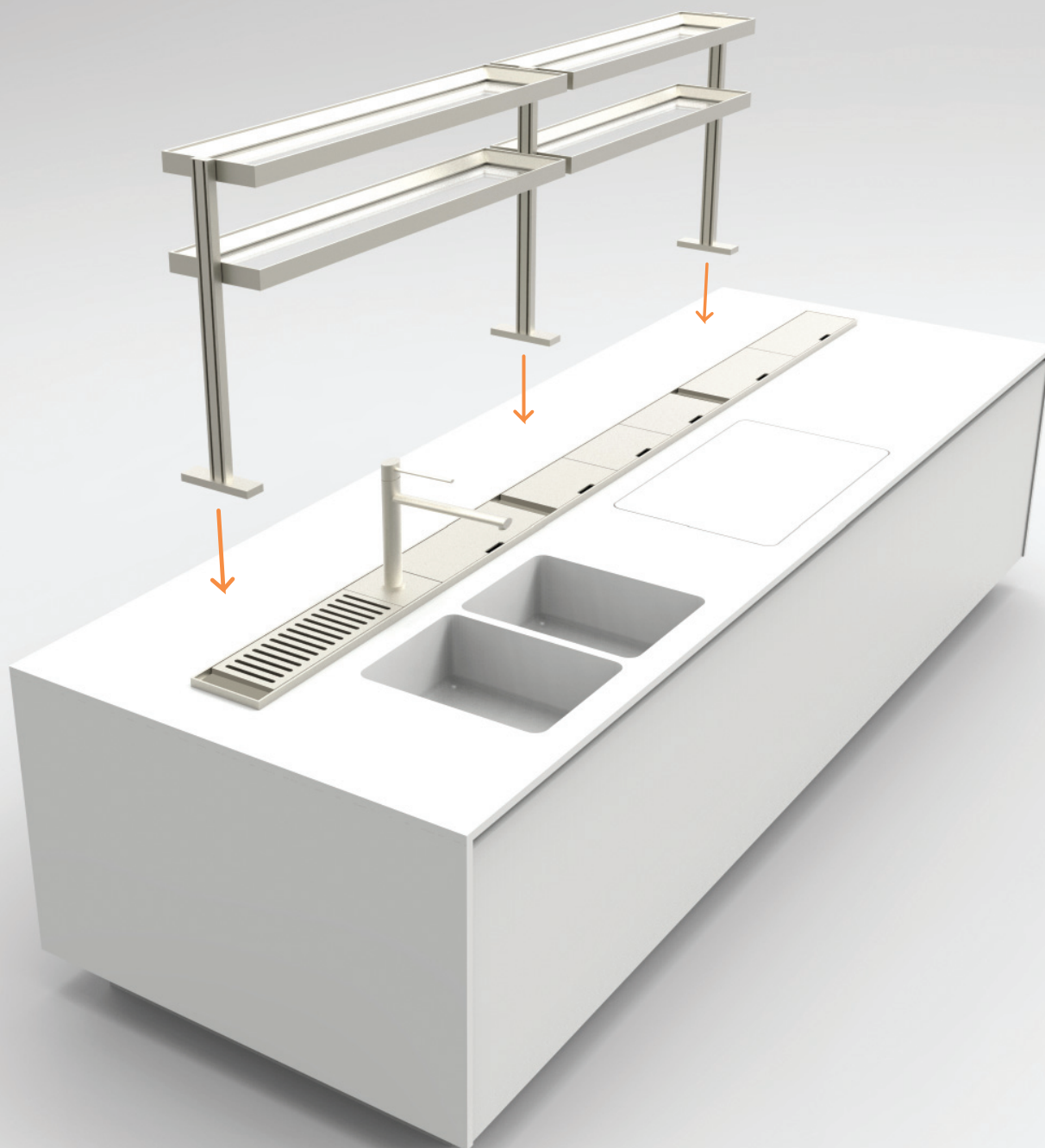



EASYSHELF

Mensole / Shelves

Esempio di fissaggio dei montanti EasyShelf alle basette predisposte sul canale EasyRack.

Fastening's example of EasyShelf's struts to the plates prepared on EasyRack frame.

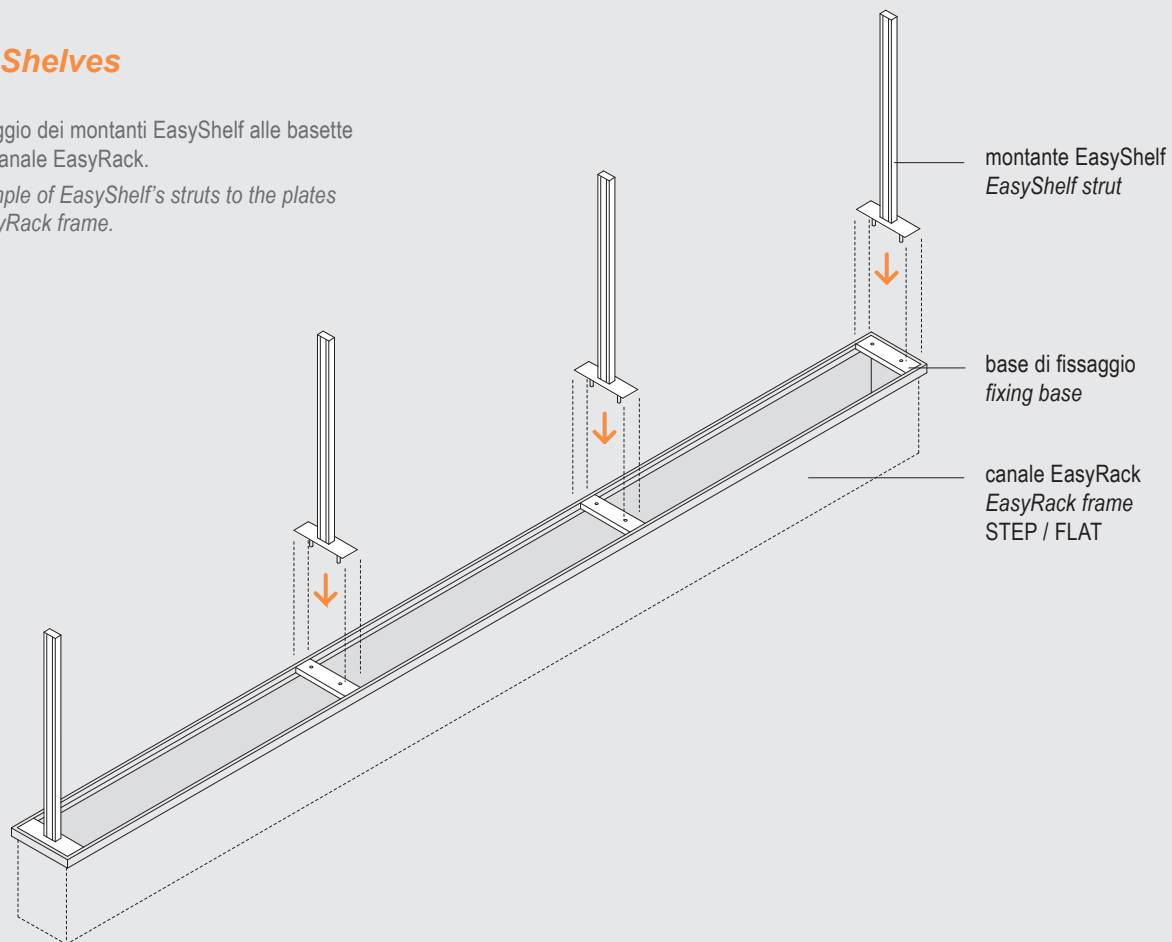

Esempio di fissaggio delle mensole EasyShelf ai montanti.

Fastening's example of EasyShelf's shelves to the struts.

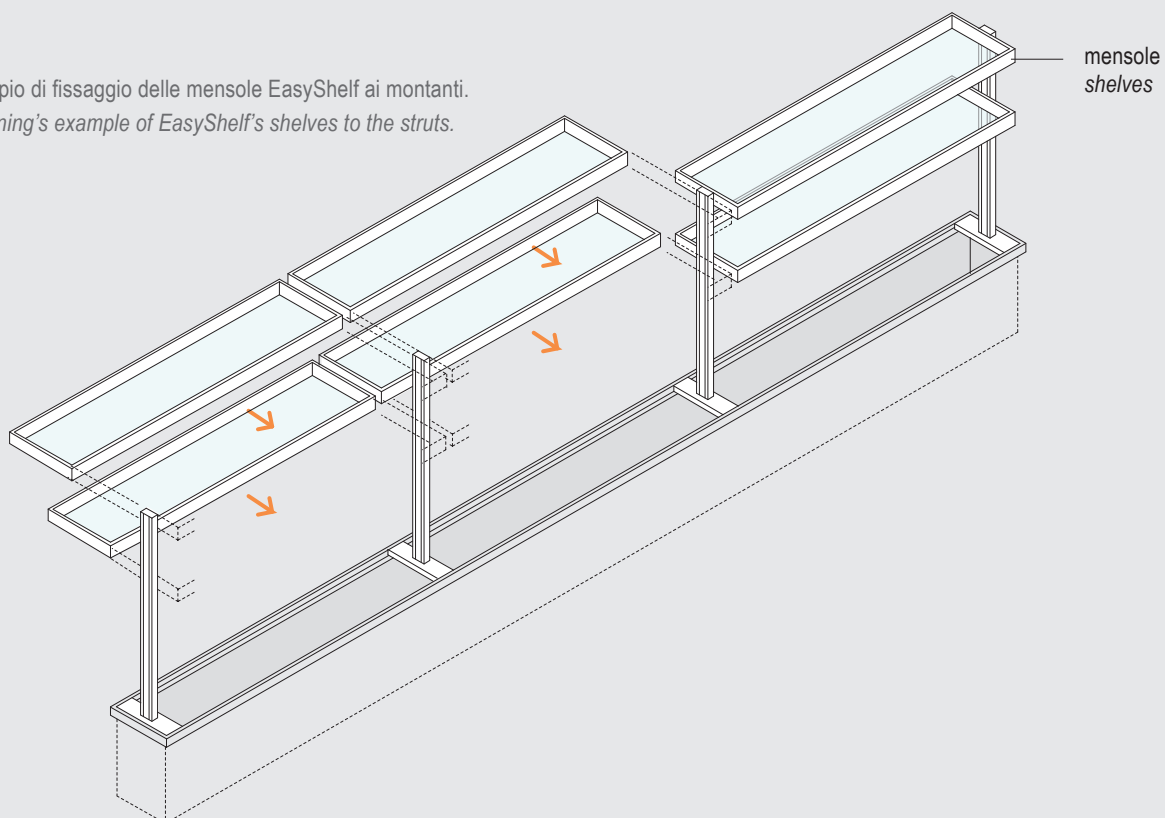



EASYSHELF

Mensole / Shelves**ALL**

Esempio di composizione EasyShelf sviluppata su tutta la lunghezza del canale EasyRack Kitchen.

Example of EasyShelf's composition develop over the entire length of EasyRack Kitchen frame.

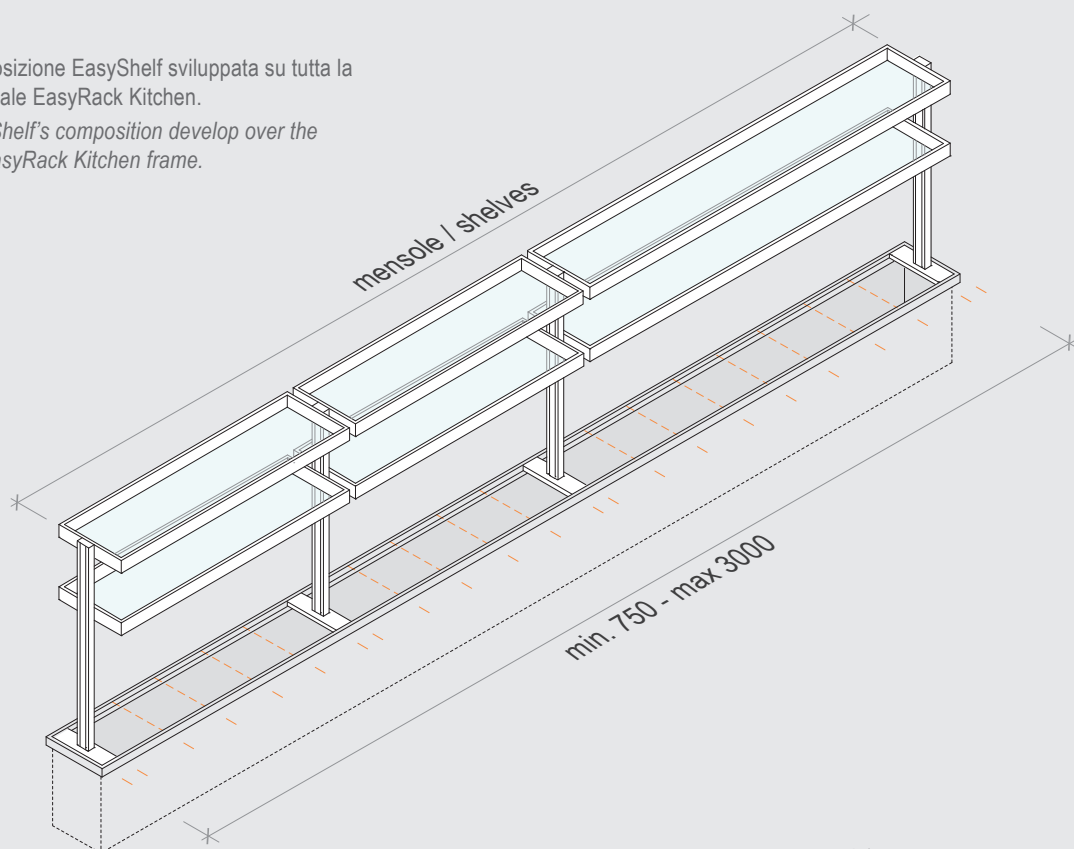
**DXIRH**

Esempio di composizione EasyShelf posizionata a destra del canale EasyRack Kitchen.

Example of EasyShelf's composition arranged on the right side of EasyRack Kitchen frame.

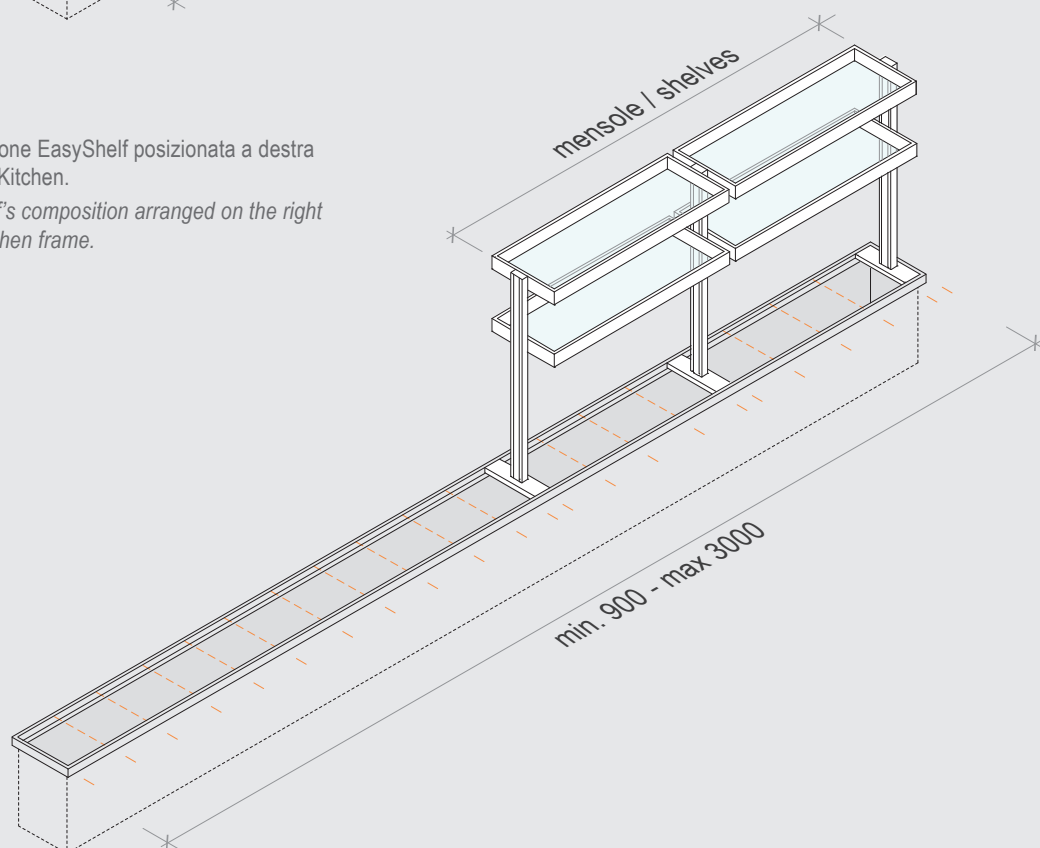



EASYSHELF

Mensole / Shelves**SX/LH**

Esempio di composizione EasyShelf posizionata a sinistra del canale EasyRack Kitchen.

Example of EasyShelf's composition arranged on the left side of EasyRack Kitchen frame.

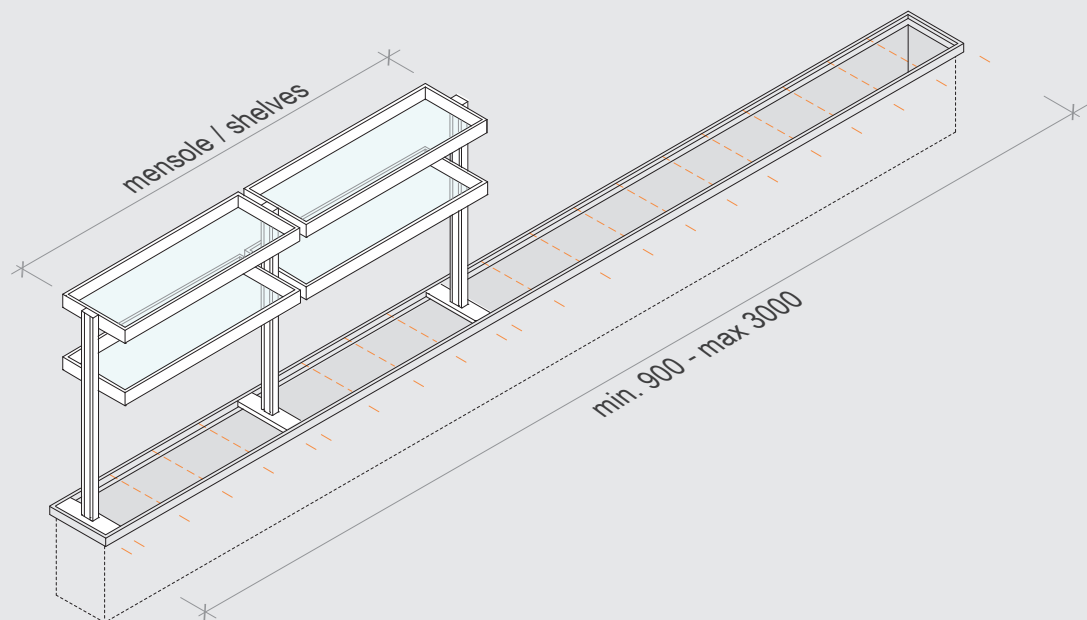
**CENTRAL**

Esempio di composizione EasyShelf posizionata al centro del canale EasyRack Kitchen.

Example of EasyShelf's composition arranged in the middle of EasyRack Kitchen frame.

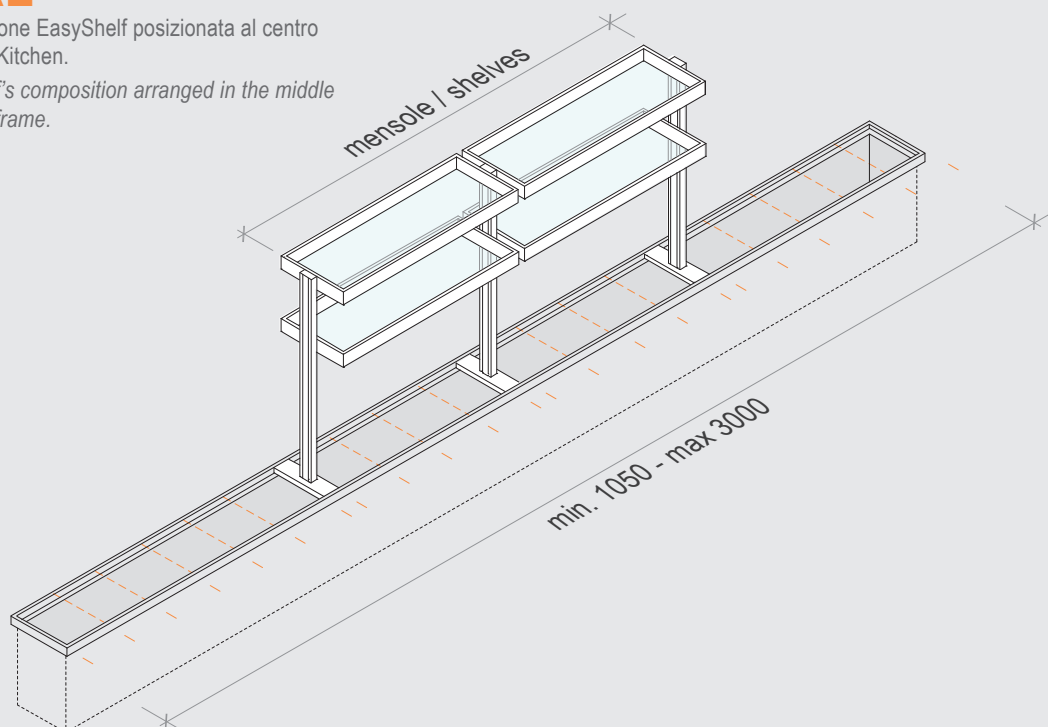

EASYSHELF

Mensole / Shelves

CENTRATE PER ISOLA

Esempio di composizione EasyShelf H 720 con 1, 2 o 3 mensole collocate rispettando il centro del canale EasyRack STEP o FLAT. Questa soluzione è consigliata per l'utilizzo del canale EasyRack sulle cucine ad isola.

Example of EasyShelf's composition H 720 with 1, 2 or 3 shelves arranged respecting the middle of EasyRack STEP or FLAT frame. This is a recommended solution for the EasyRack frame's utilization on kitchen islands.

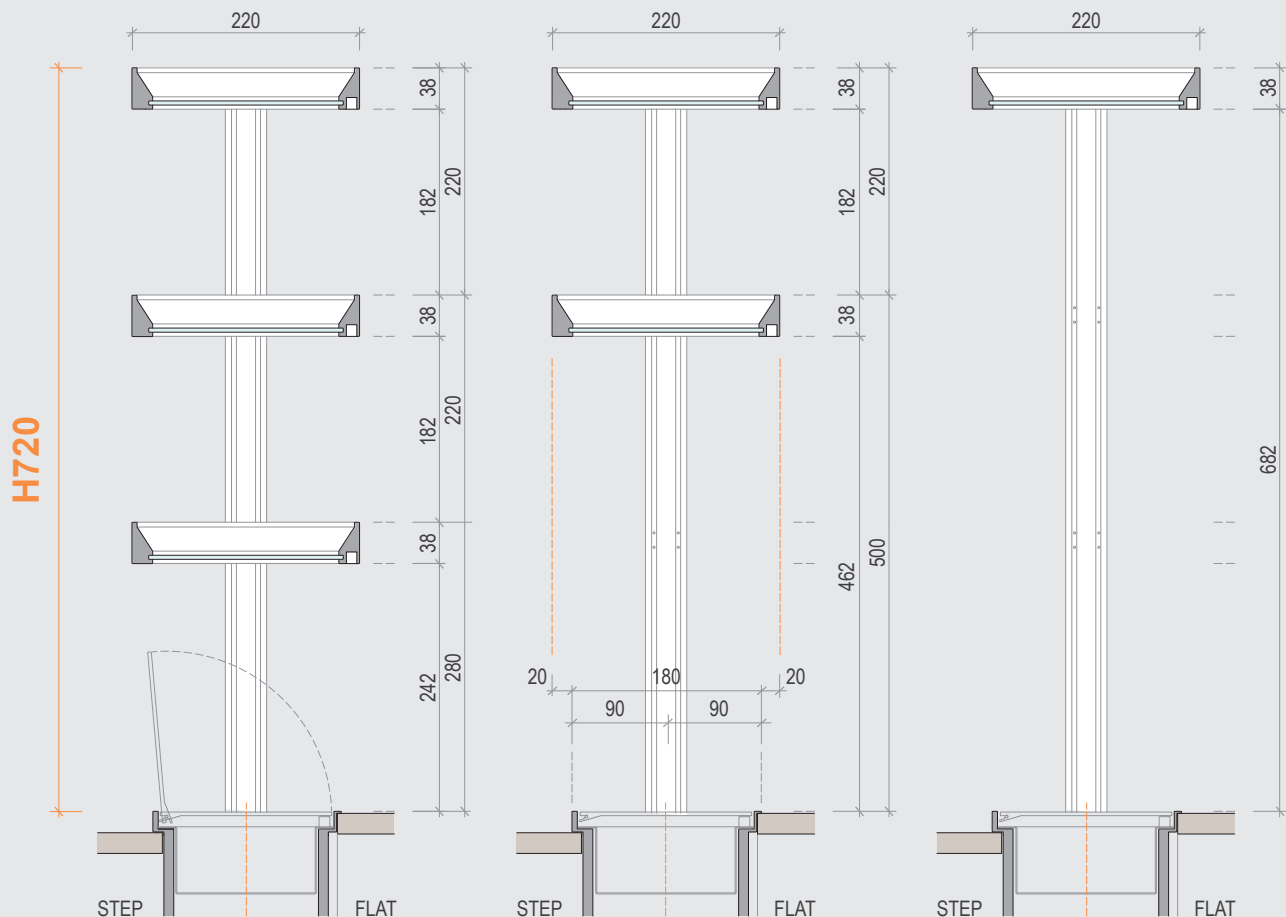
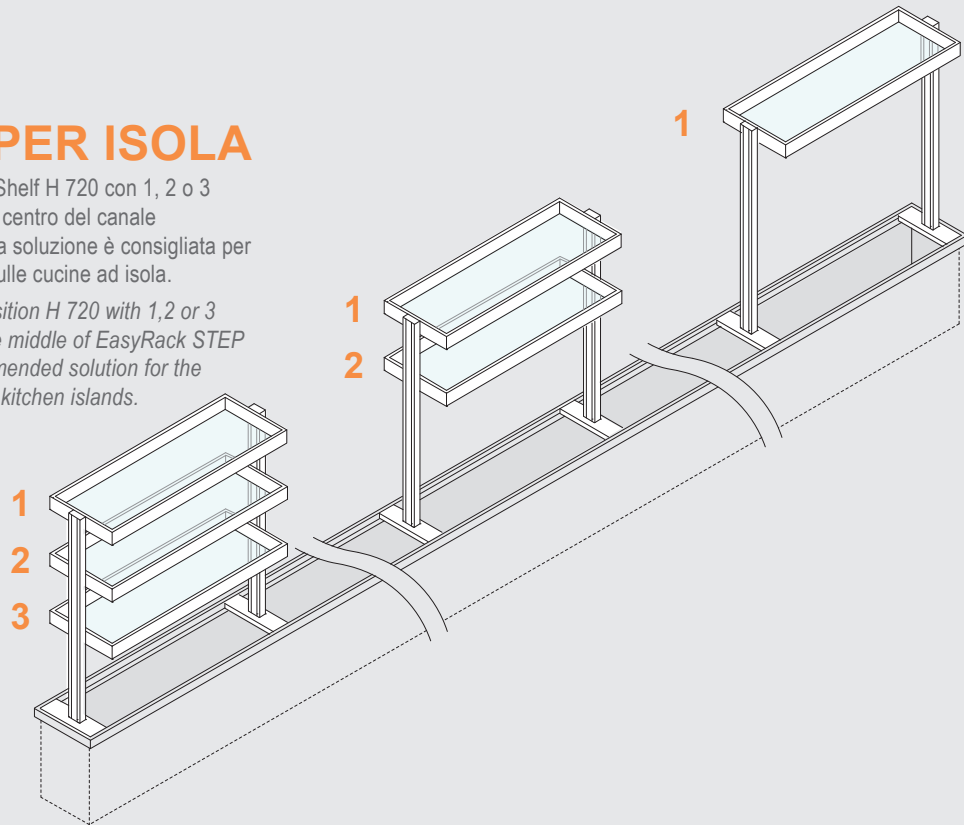



EASYSHELF

Mensole / Shelves

DECENTRATE A PARETE

Esempio di composizione EasyShelf H 720 con 1, 2 o 3 mensole allineate al filo posteriore del canale EasyRack STEP o FLAT. Questa soluzione è consigliata per l'utilizzo del canale EasyRack contro la parete.

Example of EasyShelf's composition H 720 with 1, 2 or 3 shelves aligned to the rear edge of EasyRack STEP or FLAT frame. This is a recommended solution for the EasyRack frame's utilization against the wall.

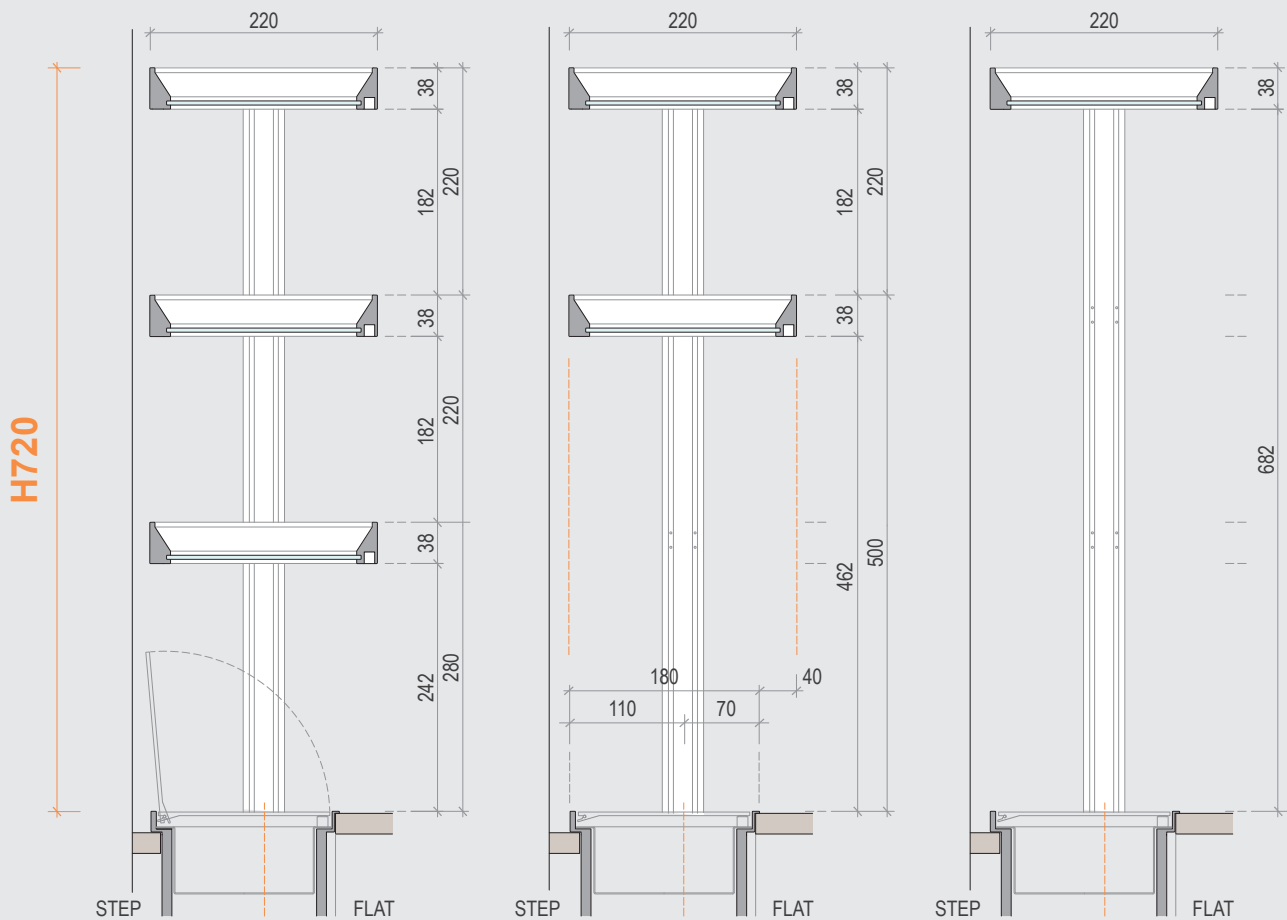
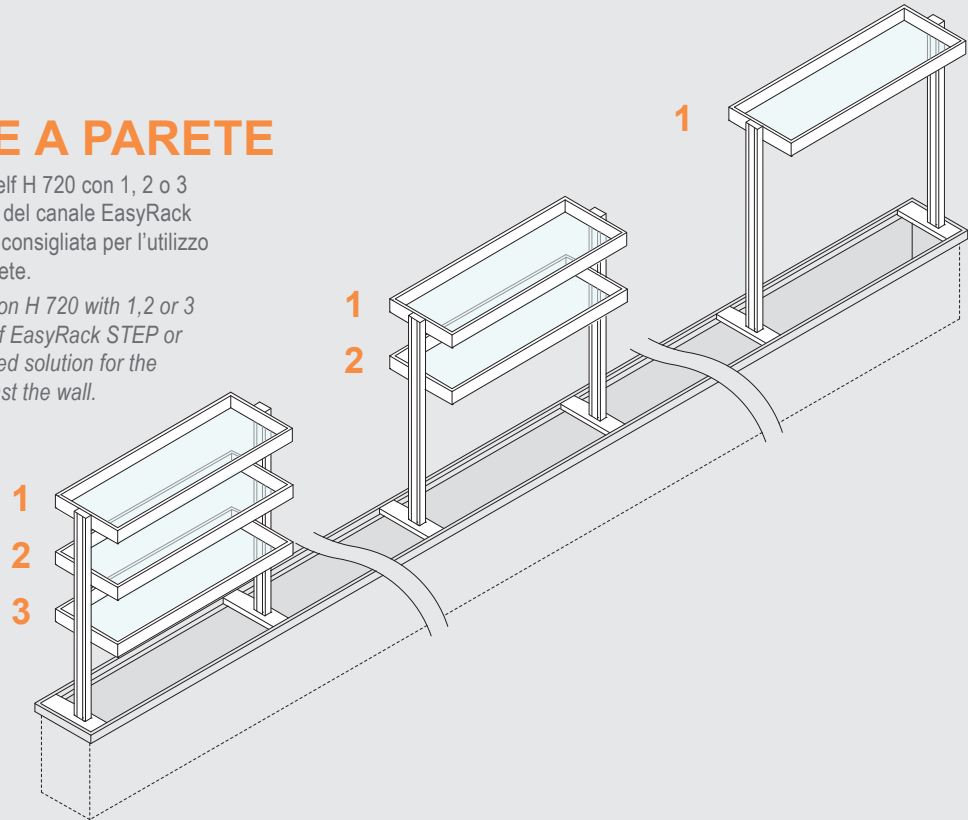



EASYSHELF

Mensole / Shelves

CENTRATE PER ISOLA

Esempio di composizione EasyShelf H 500 con 1 o 2 mensole collocate rispettando il centro del canale EasyRack STEP o FLAT. Questa soluzione è consigliata per l'utilizzo del canale EasyRack sulle cucine ad isola.

Example of EasyShelf's composition H 500 with 1 or 2 shelves arranged respecting the middle of EasyRack STEP or FLAT frame. This is a recommended solution for the EasyRack frame's utilization on kitchen islands.

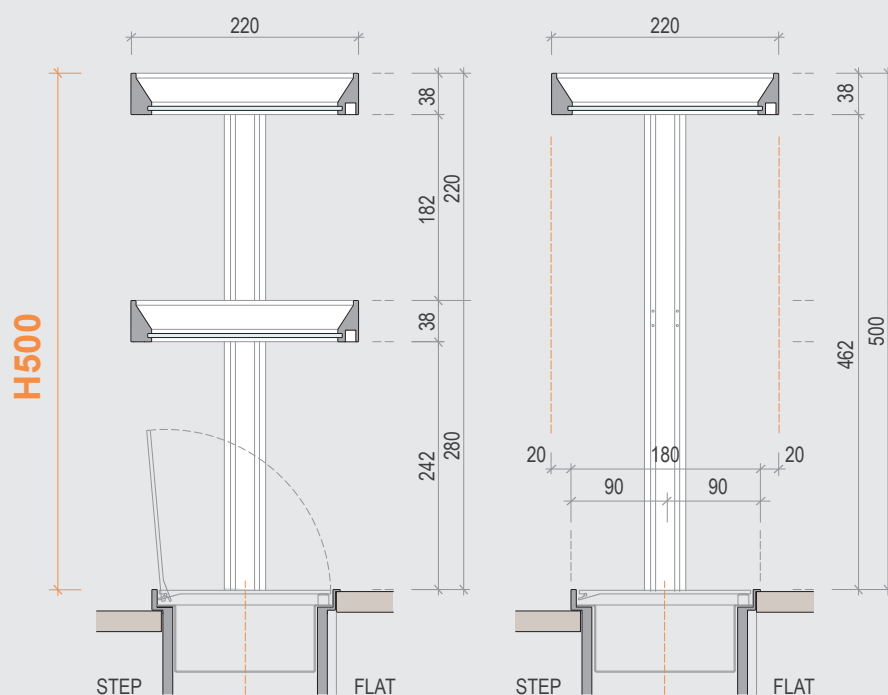
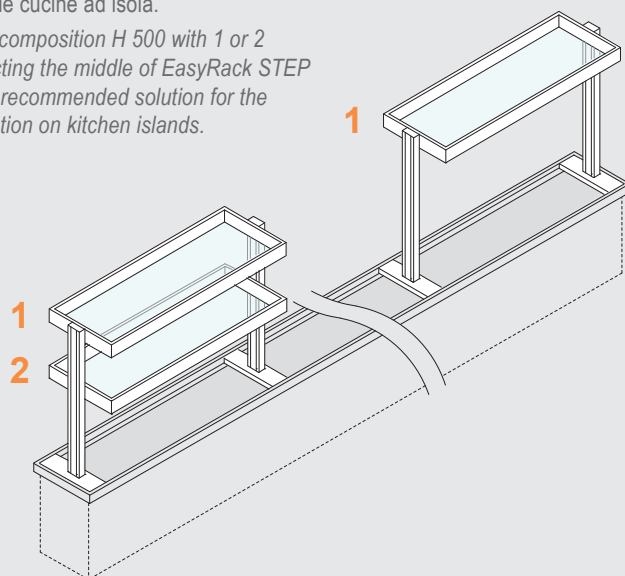



EASYSHELF

Mensole / Shelves**DECENTRATE A PARETE**

Esempio di composizione EasyShelf H 500 con 1 o 2 mensole allineate al filo posteriore del canale EasyRack STEP o FLAT. Questa soluzione è consigliata per l'utilizzo del canale EasyRack contro la parete.

Example of EasyShelf's composition H 500 with 1 or 2 shelves aligned to the rear edge of EasyRack STEP or FLAT frame. This is a recommended solution for the EasyRack frame's utilization against the wall.

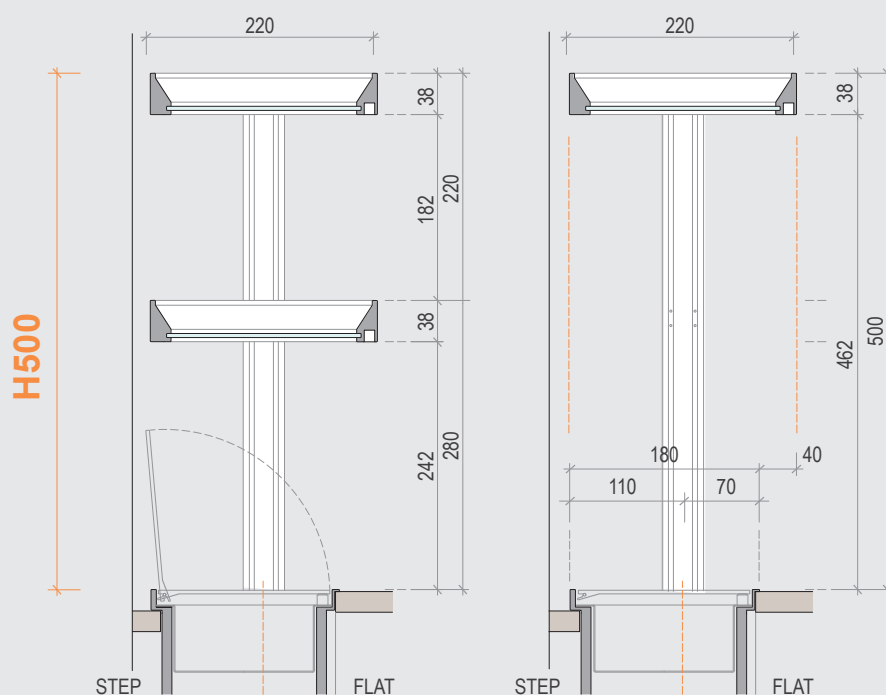
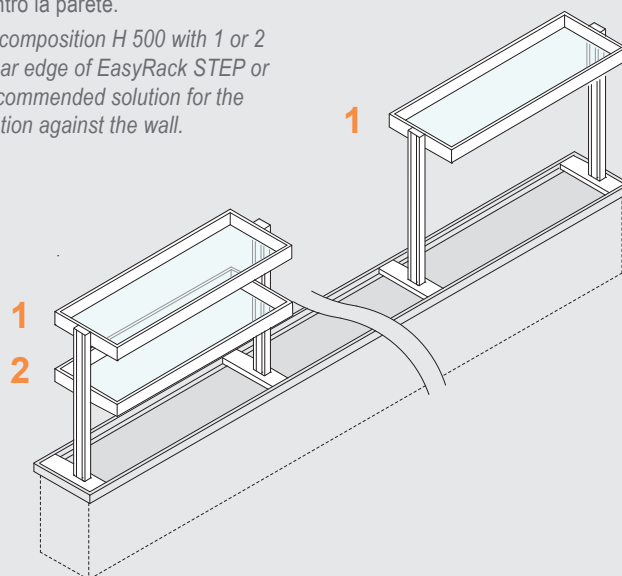

EASYSHELF

Abaco composizioni ALL / ALL Compositions index

Rappresentazione del sistema montato sui canali EasyRack Kitchen della stessa misura della composizione EasyShelf.

Per alcune misure di canali EasyRack è possibile utilizzare differenti composizioni EasyShelf.

Lo spazio che rimane tra le basi di appoggio e i montanti EasyShelf rispetta la modularità degli accessori EasyRack.

E' possibile montare le composizioni proposte anche su misure più lunghe di canali STEP o FLAT, in questo caso occorre decidere la posizione dove collocarla rispetto al canale EasyRack. Le composizioni asimmetriche sono disponibili destre o sinistre.

Representation of the system mounted on EasyRack Kitchen frames with same measure of EasyShelf's composition.

For some of EasyRack frame's measures it is possible to use different EasyShelf's composition.

The space between the supports bases and EasyShelf's strut respects the modularity of EasyRack's accessorizes. It is possible mount the proposals compositions also on longer measures of STEP or FLAT frames. In this case, it will be necessary to decide the placement position respect to EasyRack frame.

The asymmetrical compositions are available right or left.

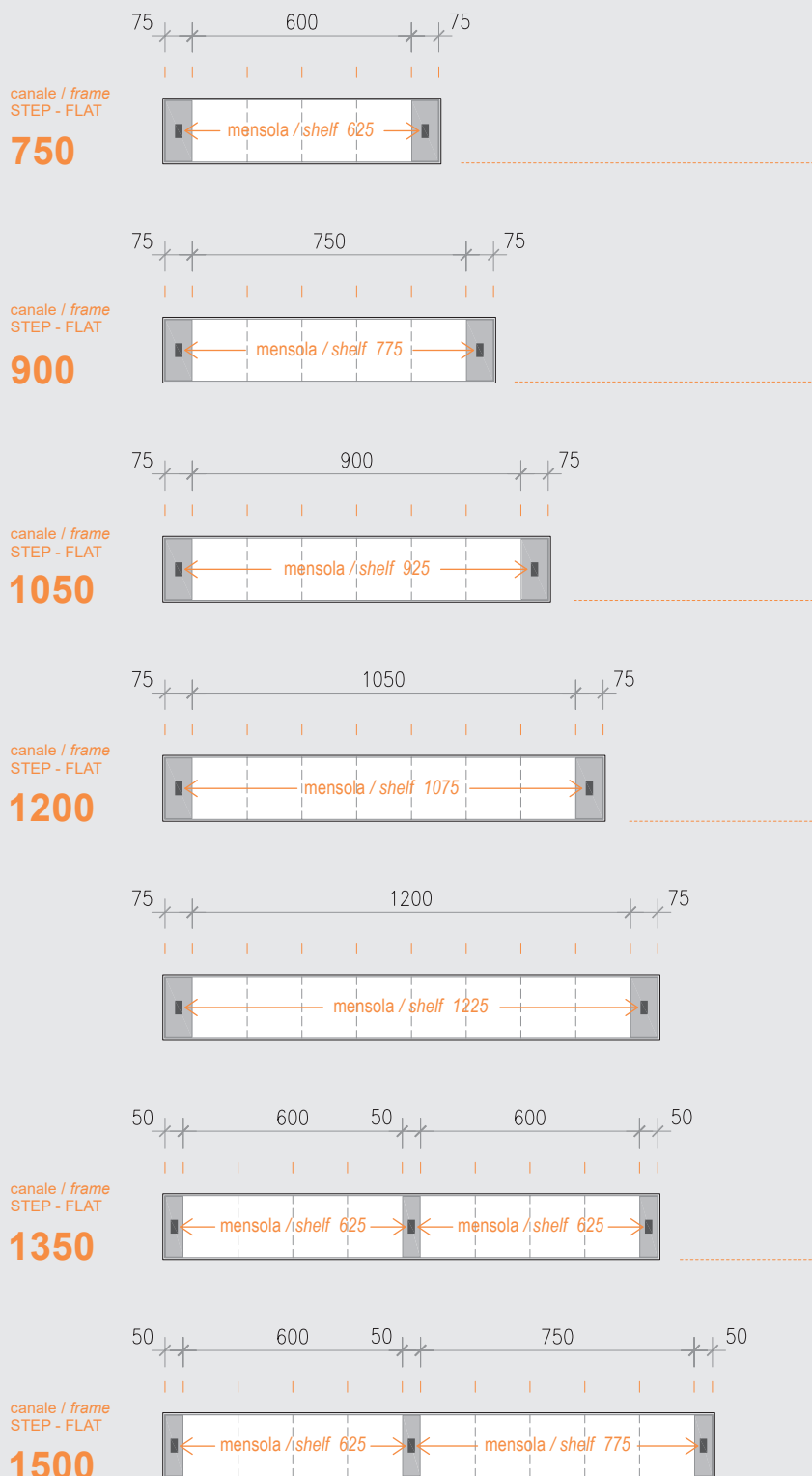



EASYSHELF

Abaco composizioni ALL / ALL Compositions index

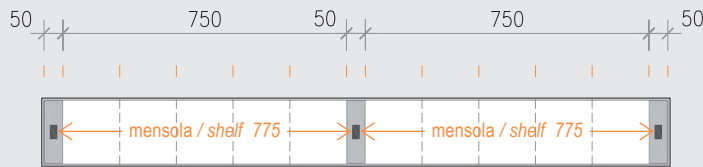

canale / frame
STEP - FLAT

1650

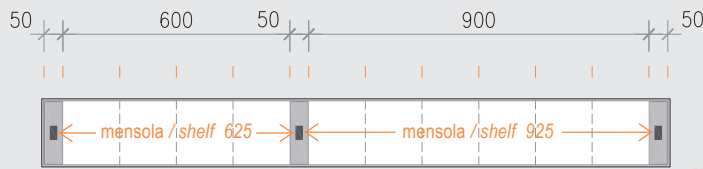

canale / frame
STEP - FLAT

1800

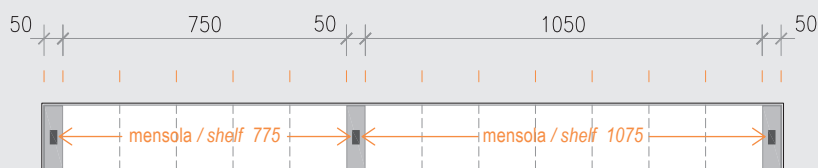
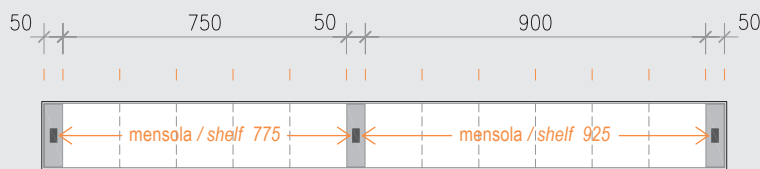

canale / frame
STEP - FLAT

1950

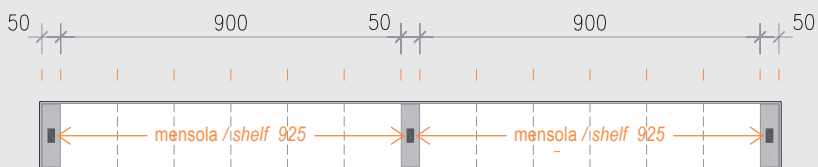



EASYSHELF

Abaco composizioni ALL / ALL Compositions index

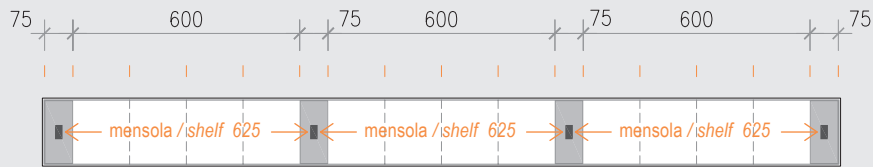

canale / frame
STEP - FLAT

2100

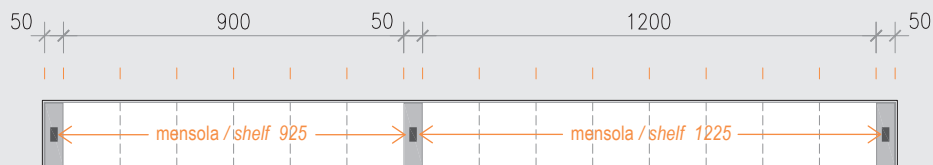
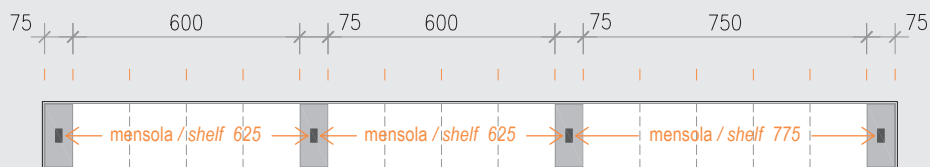
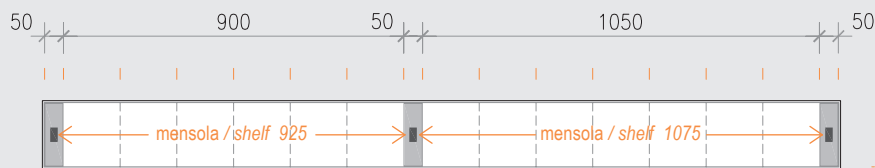

canale / frame
STEP - FLAT

2250

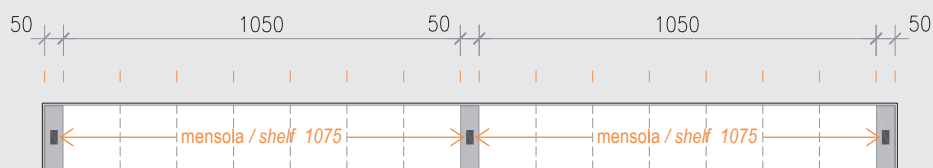



EASYSHELF

Abaco composizioni ALL / ALL Compositions index

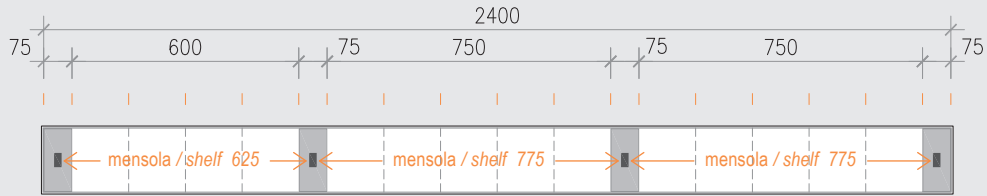
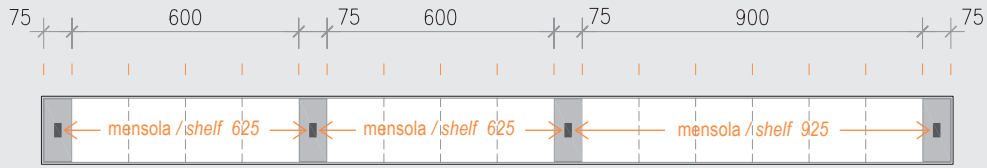

canale / frame
STEP - FLAT

2400

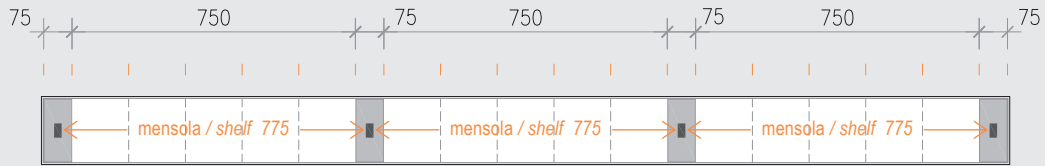
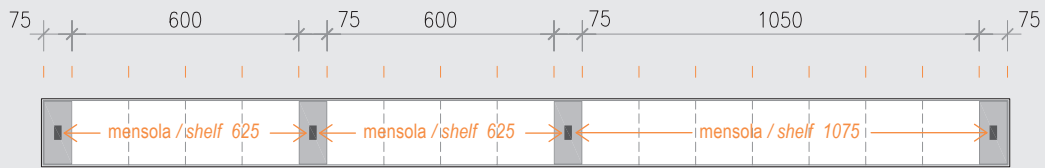
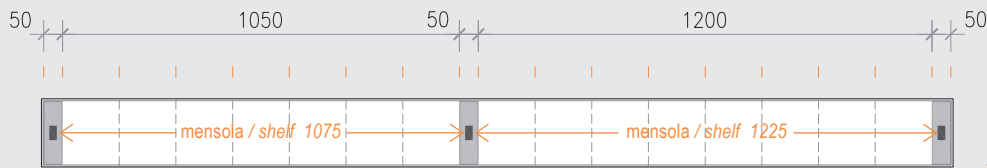

canale / frame
STEP - FLAT

2550

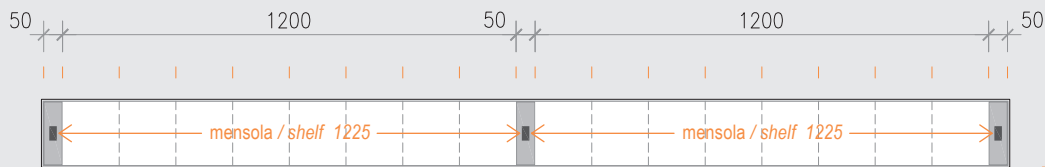



EASYSHELF

Abaco composizioni ALL / ALL Compositions index

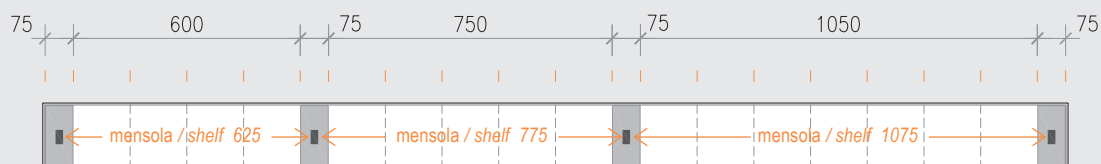
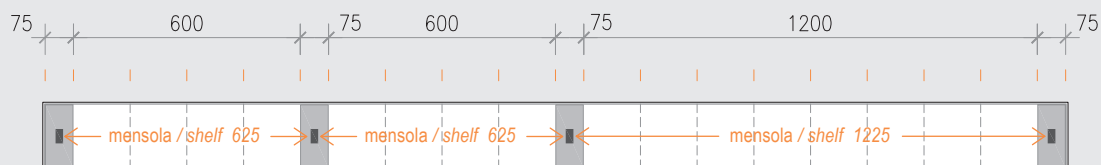
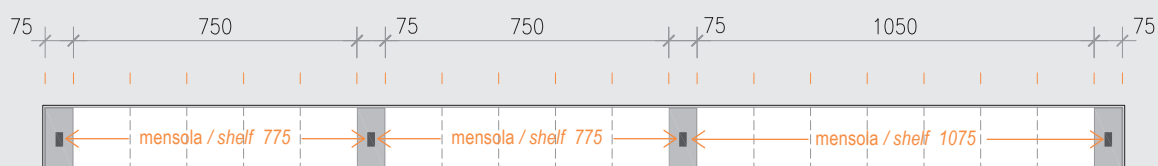
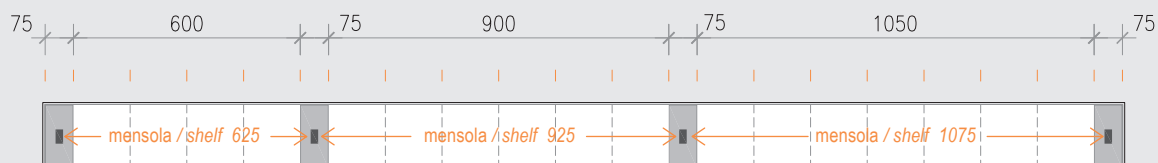
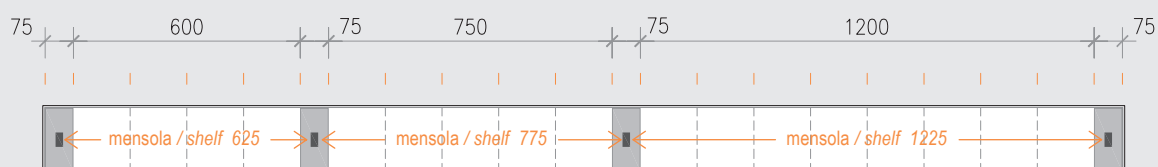
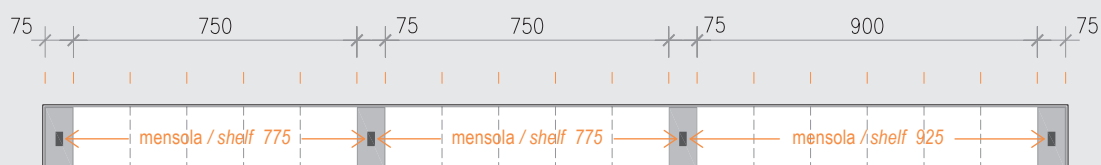
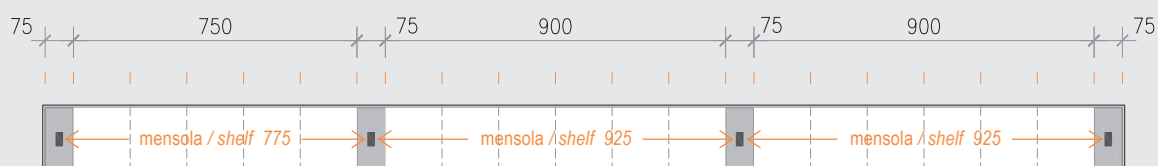
canale / frame
STEP - FLAT**2700**canale / frame
STEP - FLAT**2850**



EASYSHELF

Abaco composizioni ALL / ALL Compositions index

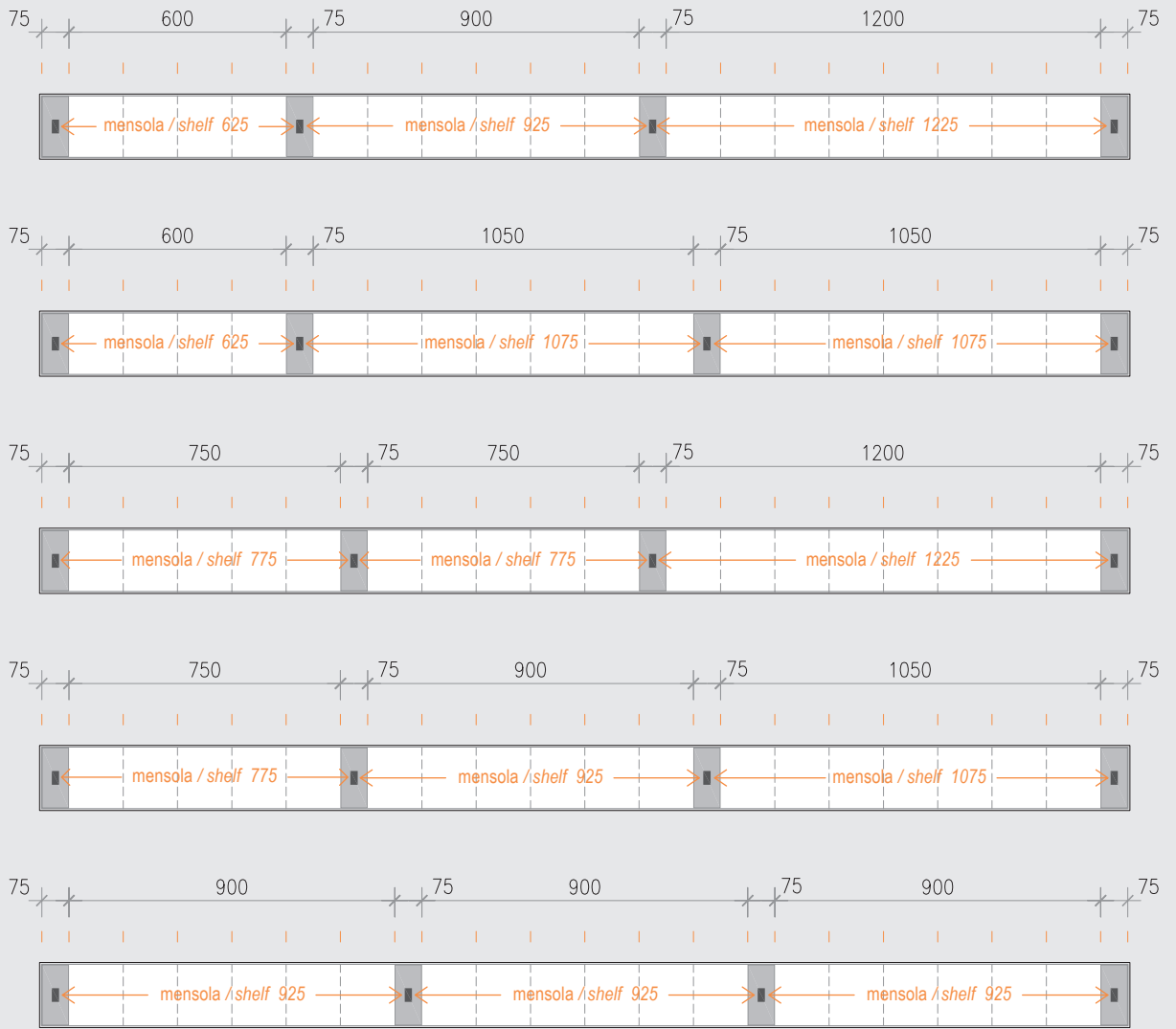

canale / frame
STEP - FLAT
3000



EASYSHELF

Mensole / Shelves

Le mensole EasyShelf hanno una profondità di 220 mm e sono realizzate con una cornice in alluminio alta 40 mm che include un vetro temperato trasparente con spessore da 4 mm. Sul lato lungo è possibile inserire una o due luci a Led.

EasyShelf's shelves have a depth of 220 mm and are made with an aluminum frame with 40 mm of height, which include transparent and tempered glass with 4mm of depth. On the long side, it is possible to insert one or two Led light.

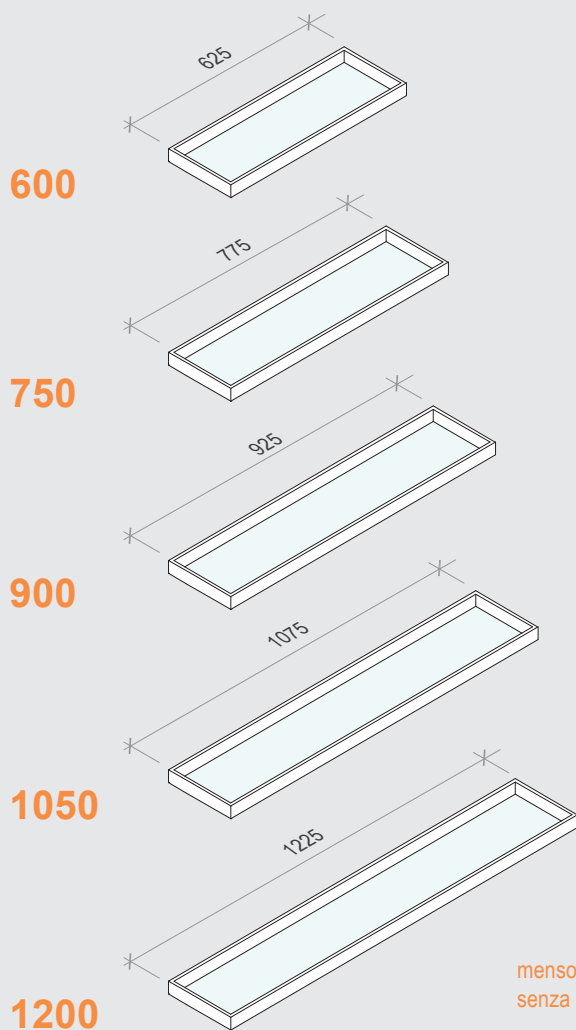

mensola / shelf
senza luce

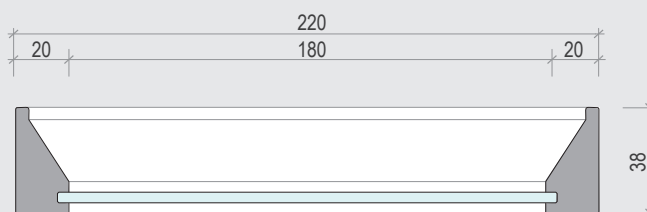

mensola / shelf
con luce Led
3000 o 4000 K
singola

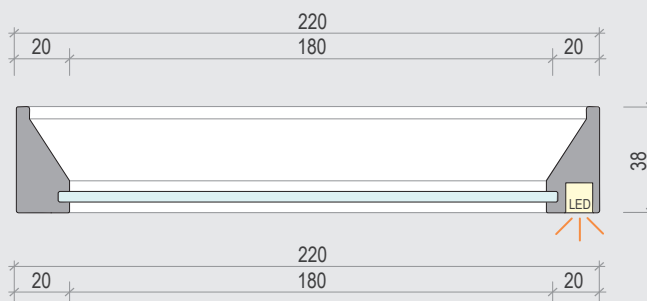

mensola / shelf
con luce Led
3000 o 4000 K
doppia

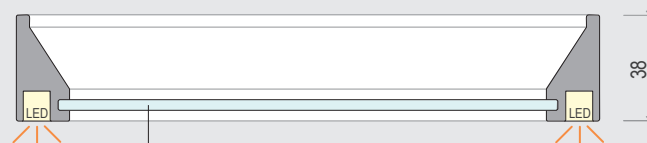

Fondo in vetro temperato
trasparente da 4 mm

